

Decision Procedures

An Algorithmic Point of View

Equalities and Uninterpreted Functions

D. Kroening O. Strichman

ETH/Technion

Version 1.0, 2007

Part III

Equalities and Uninterpreted Functions

- 1 Introduction to Equality Logic
 - Definition, complexity
- 2 Reducing uninterpreted functions to Equality Logic
- 3 Using uninterpreted functions in proofs
- 4 Simplifications

- A Boolean combination of Equalities and Propositions

$$x_1 = x_2 \wedge (x_2 = x_3 \vee \neg((x_1 = x_3) \wedge b \wedge x_1 = 2))$$

- We always push negations inside (NNF):

$$x_1 = x_2 \wedge (x_2 = x_3 \vee ((x_1 \neq x_3) \wedge \neg b \wedge x_1 \neq 2))$$

$$\begin{array}{l} \textit{formula} : \textit{formula} \vee \textit{formula} \\ | \neg \textit{formula} \\ | \textit{atom} \end{array}$$
$$\begin{array}{l} \textit{atom} : \textit{term-variable} = \textit{term-variable} \\ | \textit{term-variable} = \textit{constant} \\ | \textit{Boolean-variable} \end{array}$$

- The *term-variables* are defined over some (possible infinite) domain. The constants are from the same domain.
- The set of Boolean variables is always separate from the set of term variables

- Allows more natural description of systems, although technically it is as expressible as Propositional Logic.
- Obviously NP-hard.
- In fact, it is in NP, and hence NP-complete, for reasons we shall see later.

formula : *formula* \vee *formula*
| \neg *formula*
| *atom*

atom : *term* = *term*
| *Boolean-variable*

term : *term-variable*
| *function* (list of *terms*)

The *term-variables* are defined over some (possible infinite) domain.
Constants are functions with an empty list of terms.

- Every function is a mapping from a domain to a range.
- Example: the '+' function over the naturals \mathbb{N} is a mapping from $\langle \mathbb{N} \times \mathbb{N} \rangle$ to \mathbb{N} .

- Suppose we replace '+' by an uninterpreted binary function $f(a, b)$
- Example:

$$x_1 + x_2 = x_3 + x_4 \quad \text{is replaced by} \quad f(x_1, x_2) = f(x_3, x_4)$$

- We lost the 'semantics' of '+', as f can represent **any binary function**.
- 'Losing the semantics' means that f is not restricted by any axioms or rules of inference.
- But f is still a function!

- The most general axiom for any function is **functional consistency**.
- Example: if $x = y$, then $f(x) = f(y)$ for any function f .

- Functional consistency axiom schema:

$$x_1 = x'_1 \wedge \dots \wedge x_n = x'_n \implies f(x_1, \dots, x_n) = f(x'_1, \dots, x'_n)$$

- Sometimes, functional consistency is all that is needed for a proof.

- Circuits consist of combinational gates and latches (registers)

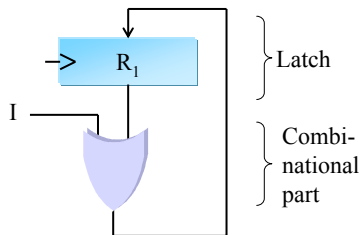

- Circuits consist of combinational gates and latches (registers)
- The combinational gates can be modeled using functions
- The latches can be modeled with variables

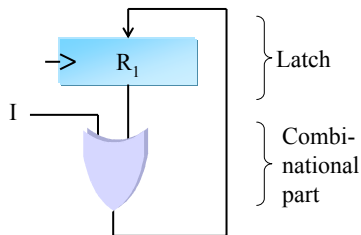

$$f(x, y) := x \vee y$$

$$R'_1 = f(R_1, I)$$

Example: Circuit Transformations

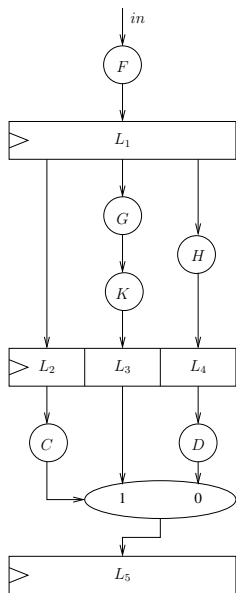

Example: Circuit Transformations

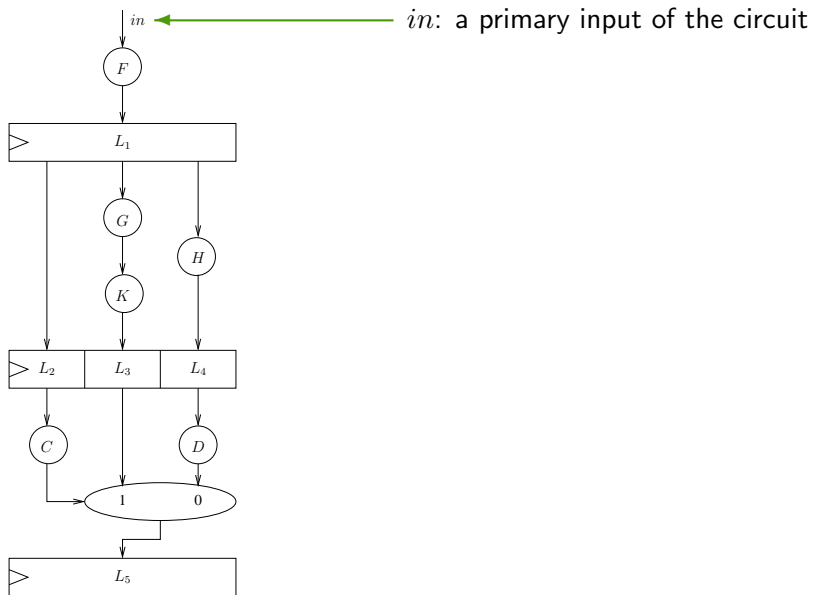

Example: Circuit Transformations

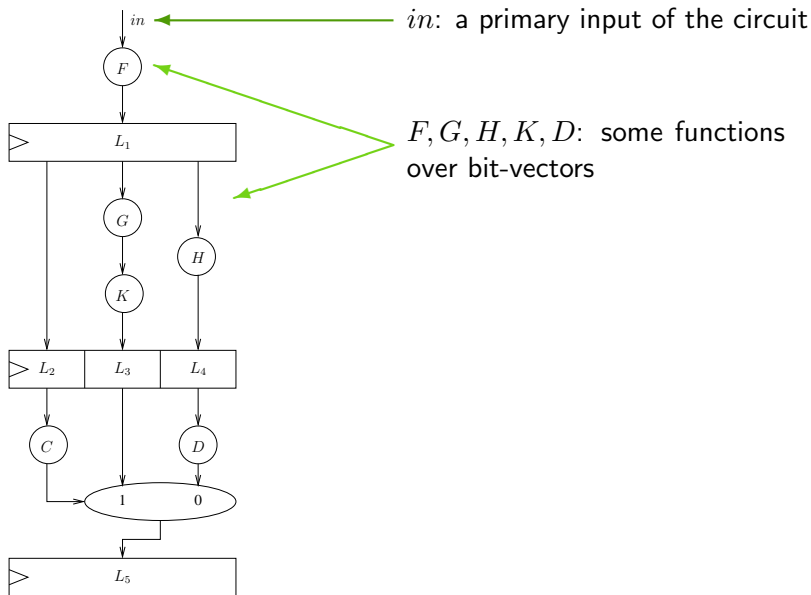

Example: Circuit Transformations

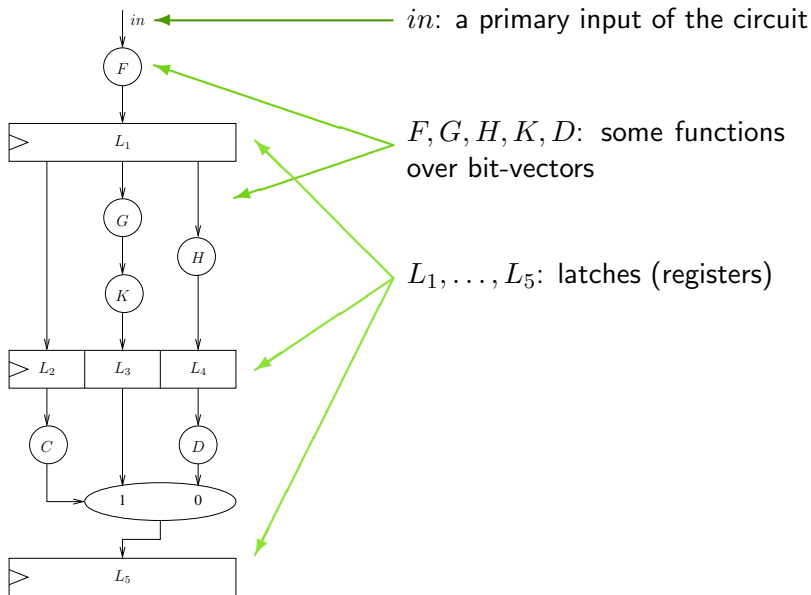

Example: Circuit Transformations

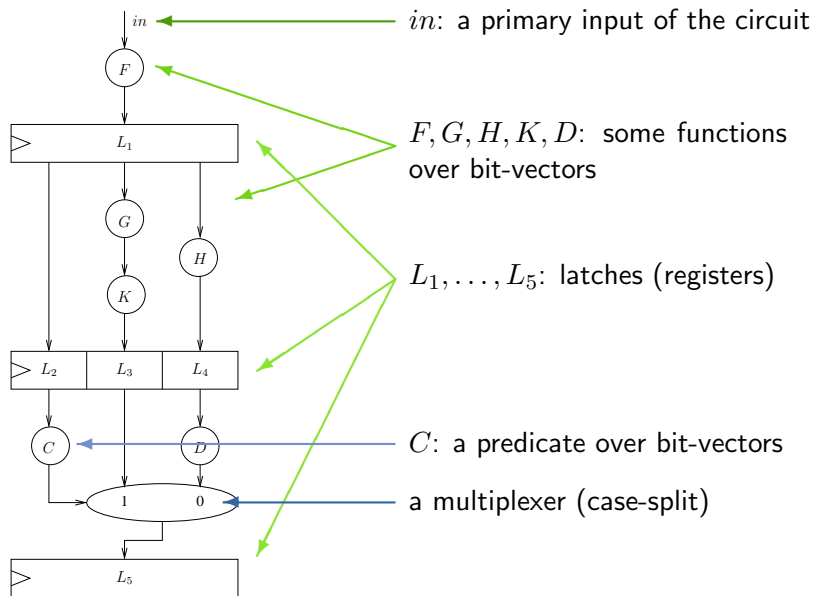

Example: Circuit Transformations

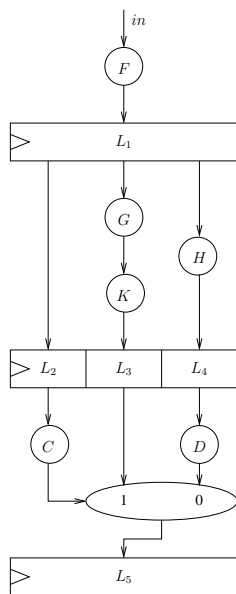

- A pipeline processes data in *stages*
- Data is processed in parallel – as in an assembly line
- Formal model:

$$L_1 = f(I)$$

$$L_2 = L_1$$

$$L_3 = k(g(L_1))$$

$$L_4 = h(L_1)$$

$$L_5 = c(L_2) ? L_3 : l(L_4)$$

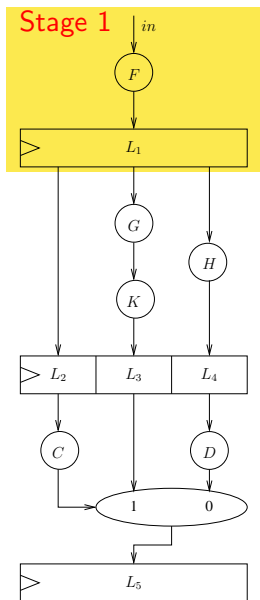

- A pipeline processes data in *stages*
- Data is processed in parallel – as in an assembly line
- Formal model:

$$L_1 = f(I)$$

$$L_2 = L_1$$

$$L_3 = k(g(L_1))$$

$$L_4 = h(L_1)$$

$$L_5 = c(L_2) ? L_3 : l(L_4)$$

Example: Circuit Transformations

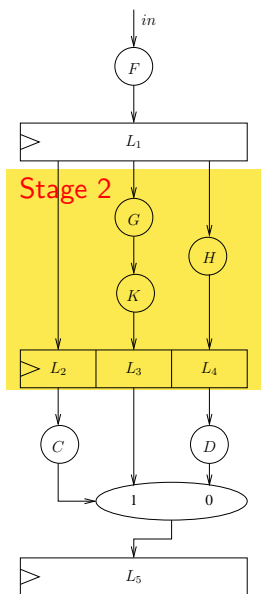

- A pipeline processes data in *stages*
- Data is processed in parallel – as in an assembly line
- Formal model:

$$L_1 = f(I)$$

$$L_2 = L_1$$

$$L_3 = k(g(L_1))$$

$$L_4 = h(L_1)$$

$$L_5 = c(L_2) ? L_3 : l(L_4)$$

Example: Circuit Transformations

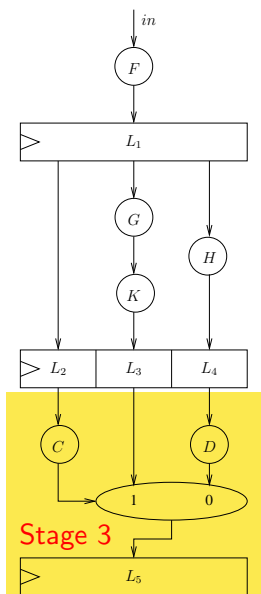

- A pipeline processes data in *stages*
- Data is processed in parallel – as in an assembly line
- Formal model:

$$L_1 = f(I)$$

$$L_2 = L_1$$

$$L_3 = k(g(L_1))$$

$$L_4 = h(L_1)$$

$$L_5 = c(L_2) ? L_3 : l(L_4)$$

Example: Circuit Transformations

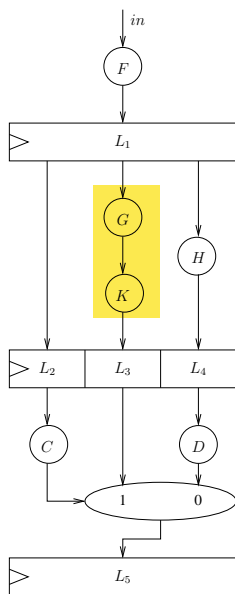

- The maximum clock frequency depends on the **longest path** between two latches
- Note that the output of g is used as input to k
- We want to speed up the design by postponing k to the third stage

Example: Circuit Transformations

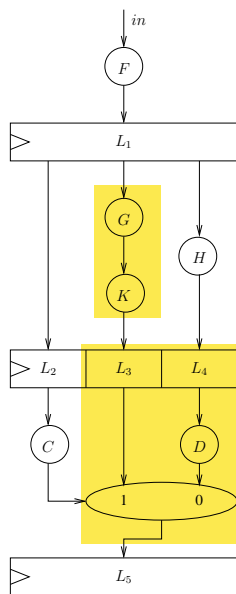

- The maximum clock frequency depends on the **longest path** between two latches
 - Note that the output of g is used as input to k
 - We want to speed up the design by postponing k to the third stage
 - Also note that the circuit only uses one of L_3 or L_4 , never both
- ⇒ We can remove one of the latches

Example: Circuit Transformations

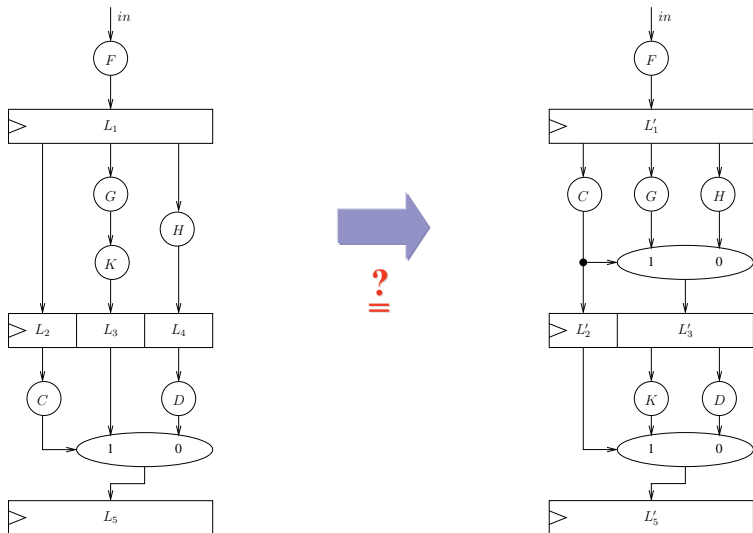

$$L_1 = f(I)$$

$$L_2 = L_1$$

$$L_3 = k(g(L_1))$$

$$L_4 = h(L_1)$$

$$L_5 = c(L_2) ? L_3 : l(L_4)$$

$$L'_1 = f(I)$$

$$L'_2 = c(L'_1)$$

$$L'_3 = c(L'_1) ? g(L'_1) : h(L'_1)$$

$$L'_5 = L'_2 ? k(L'_3) : l(L'_3)$$

$$L_5 \stackrel{?}{=} L'_5$$

$$L_1 = f(I)$$

$$L_2 = L_1$$

$$L_3 = k(g(L_1))$$

$$L_4 = h(L_1)$$

$$L_5 = c(L_2) ? L_3 : l(L_4)$$

$$L'_1 = f(I)$$

$$L'_2 = c(L'_1)$$

$$L'_3 = c(L'_1) ? g(L'_1) : h(L'_1)$$

$$L'_5 = L'_2 ? k(L'_3) : l(L'_3)$$

$$L_5 \stackrel{?}{=} L'_5$$

- Equivalence in this case holds **regardless of the actual functions**
- Conclusion: can be decided using *Equality Logic and Uninterpreted Functions*

- Given: a formula φ^{UF} with uninterpreted functions
- For each function in φ^{UF} :
 1. Number function instances $\longrightarrow F_2(F_1(x)) = 0$
(from the inside out)

- Given: a formula φ^{UF} with uninterpreted functions
- For each function in φ^{UF} :

1. Number function instances (from the inside out) \longrightarrow $\underbrace{F_2(\overbrace{F_1(x)}^{f_1})}_{f_2} = 0$

2. Replace each function instance with a new variable $\longrightarrow f_2 = 0$

- Given: a formula φ^{UF} with uninterpreted functions
- For each function in φ^{UF} :

1. Number function instances (from the inside out) \longrightarrow $\underbrace{F_2(\overbrace{F_1(x)}^{f_1})}_{f_2} = 0$

2. Replace each function instance with a new variable $\longrightarrow f_2 = 0$

3. Add functional consistency constraint to φ^{UF} for every pair of instances of the same function. $\longrightarrow ((x = f_1) \longrightarrow (f_2 = f_1))$
 $\longrightarrow f_2 = 0$

Suppose we want to check

$$x_1 \neq x_2 \vee F(x_1) = F(x_2) \vee F(x_1) \neq F(x_3)$$

for validity.

- 1 First number the function instances:

$$x_1 \neq x_2 \vee F_1(x_1) = F_2(x_2) \vee F_1(x_1) \neq F_3(x_3)$$

Suppose we want to check

$$x_1 \neq x_2 \vee F(x_1) = F(x_2) \vee F(x_1) \neq F(x_3)$$

for validity.

- 1 First number the function instances:

$$x_1 \neq x_2 \vee F_1(x_1) = F_2(x_2) \vee F_1(x_1) \neq F_3(x_3)$$

- 2 Replace each function with a new variable:

$$x_1 \neq x_2 \vee f_1 = f_2 \vee f_1 \neq f_3$$

Suppose we want to check

$$x_1 \neq x_2 \vee F(x_1) = F(x_2) \vee F(x_1) \neq F(x_3)$$

for validity.

- 1 First number the function instances:

$$x_1 \neq x_2 \vee F_1(x_1) = F_2(x_2) \vee F_1(x_1) \neq F_3(x_3)$$

- 2 Replace each function with a new variable:

$$x_1 \neq x_2 \vee f_1 = f_2 \vee f_1 \neq f_3$$

- 3 Add **functional consistency** constraints:

$$\left(\begin{array}{l} (x_1 = x_2 \rightarrow f_1 = f_2) \quad \wedge \\ (x_1 = x_3 \rightarrow f_1 = f_3) \quad \wedge \\ (x_2 = x_3 \rightarrow f_2 = f_3) \end{array} \right) \rightarrow$$

$$((x_1 \neq x_2) \vee (f_1 = f_2) \vee (f_1 \neq f_3))$$

- Given: a formula φ^{UF} with uninterpreted functions
- For each function in φ^{UF} :
 1. Number function instances $\longrightarrow F_1(a) = F_2(b)$
(from the inside out)

- Given: a formula φ^{UF} with uninterpreted functions
- For each function in φ^{UF} :
 1. Number function instances $\longrightarrow F_1(a) = F_2(b)$
(from the inside out)
 2. Replace each function instance $\longrightarrow F_1^* = F_2^*$
 F_i with an expression F_i^*

- Given: a formula φ^{UF} with uninterpreted functions
- For each function in φ^{UF} :
 - Number function instances $\longrightarrow F_1(a) = F_2(b)$
(from the inside out)
 - Replace each function instance $\longrightarrow F_1^* = F_2^*$
 F_i with an expression F_i^*

$$F_i^* := \left(\begin{array}{l} \text{case } x_1 = x_i : f_1 \\ \quad x_2 = x_i : f_2 \\ \quad \vdots \\ \quad x_{i-1} = x_i : f_{i-1} \\ \quad \text{true} : f_i \end{array} \right) \longrightarrow f_1 = \left(\begin{array}{l} \text{case } a = b : f_1 \\ \quad \text{true} : f_2 \end{array} \right)$$

- Original formula:

$$a = b \rightarrow F(G(a) = F(G(b)))$$

- Original formula:

$$a = b \rightarrow F(G(a) = F(G(b)))$$

- Number the instances:

$$a = b \rightarrow F_1(G_1(a) = F_2(G_2(b)))$$

Example of Bryant's reduction

- Original formula:

$$a = b \rightarrow F(G(a) = F(G(b)))$$

- Number the instances:

$$a = b \rightarrow F_1(G_1(a) = F_2(G_2(b)))$$

- Replace each function application with an expression:

$$a = b \rightarrow F_1^* = F_2^*$$

where

$$\begin{aligned} F_1^* &= f_1 \\ F_2^* &= \left(\begin{array}{ll} \text{case } G_1^* = G_2^* & : f_1 \\ \text{true} & : f_2 \end{array} \right) \end{aligned}$$

$$\begin{aligned} G_1^* &= g_1 \\ G_2^* &= \left(\begin{array}{ll} \text{case } a = b & : g_1 \\ \text{true} & : g_2 \end{array} \right) \end{aligned}$$

- Uninterpreted functions give us the ability to represent an *abstract* view of functions.
- It **over-approximates** the concrete system.

$1 + 1 = 1$ is a contradiction

But

$F(1, 1) = 1$ is satisfiable!

- Uninterpreted functions give us the ability to represent an *abstract* view of functions.
- It **over-approximates** the concrete system.

$1 + 1 = 1$ is a contradiction

But

$F(1, 1) = 1$ is satisfiable!

- Conclusion: unless we are careful, we can give wrong answers, and this way, loose soundness.

- In general, a **sound but incomplete** method is more useful than an **unsound but complete** method.
- A **sound but incomplete** algorithm for deciding a formula with uninterpreted functions φ^{UF} :
 - 1 Transform it into Equality Logic formula φ^E
 - 2 If φ^E is unsatisfiable, return 'Unsatisfiable'
 - 3 Else return 'Don't know'

- Question #1: is this useful?

- Question #1: is this useful?
- Question #2: can it be made complete in some cases?

- Question #1: is this useful?
- Question #2: can it be made complete in some cases?

- When the abstract view is sufficient for the proof, it **enables** (or at least simplifies) a **mechanical proof**.

- Question #1: is this useful?
 - Question #2: can it be made complete in some cases?
-
- When the abstract view is sufficient for the proof, it **enables** (or at least simplifies) a **mechanical proof**.
 - So when is the abstract view sufficient?

- (common) Proving equivalence between:
 - Two versions of a hardware design (one with and one without a pipeline)
 - Source and target of a compiler ("Translation Validation")

- (common) Proving equivalence between:
 - Two versions of a hardware design (one with and one without a pipeline)
 - Source and target of a compiler ("Translation Validation")

- (rare) Proving properties that do not rely on the exact functionality of some of the functions

- Assume the source program has the statement

$$z = (x_1 + y_1) \cdot (x_2 + y_2);$$

which the compiler turned into:

$$u_1 = x_1 + y_1;$$

$$u_2 = x_2 + y_2;$$

$$z = u_1 \cdot u_2;$$

- Assume the source program has the statement

$$z = (x_1 + y_1) \cdot (x_2 + y_2);$$

which the compiler turned into:

$$u_1 = x_1 + y_1;$$

$$u_2 = x_2 + y_2;$$

$$z = u_1 \cdot u_2;$$

- We need to prove that:

$$\begin{aligned} & (u_1 = x_1 + y_1 \quad \wedge \quad u_2 = x_2 + y_2 \quad \wedge \quad z = u_1 \cdot u_2) \\ \longrightarrow & (z = (x_1 + y_1) \cdot (x_2 + y_2)) \end{aligned}$$

- Claim: φ^{UF} is valid
- We will prove this by reducing it to an Equality Logic formula

$$\varphi^E = \left(\begin{array}{l} (x_1 = x_2 \wedge y_1 = y_2 \longrightarrow f_1 = f_2) \wedge \\ (u_1 = f_1 \wedge u_2 = f_2 \longrightarrow g_1 = g_2) \end{array} \right) \longrightarrow \\ ((u_1 = f_1 \wedge u_2 = f_2 \wedge z = g_1) \longrightarrow z = g_2)$$

- Good: each function on the left can be mapped to a function on the right with equivalent arguments

- Good: each function on the left can be mapped to a function on the right with equivalent arguments
- Bad: almost all other cases
- Example:

<u>Left</u>	<u>Right</u>
$x + x$	$2x$

- This is easy to prove:

$$(x_1 = x_2 \wedge y_1 = y_2) \longrightarrow (x_1 + y_1 = x_2 + y_2)$$

- This is easy to prove:

$$(x_1 = x_2 \wedge y_1 = y_2) \longrightarrow (x_1 + y_1 = x_2 + y_2)$$

- This requires **commutativity**:

$$(x_1 = x_2 \wedge y_1 = y_2) \longrightarrow (x_1 + y_1 = y_2 + x_2)$$

- This is easy to prove:

$$(x_1 = x_2 \wedge y_1 = y_2) \longrightarrow (x_1 + y_1 = x_2 + y_2)$$

- This requires **commutativity**:

$$(x_1 = x_2 \wedge y_1 = y_2) \longrightarrow (x_1 + y_1 = y_2 + x_2)$$

- Fix by adding:

$$(x_1 + y_1 = y_1 + x_1) \wedge (x_2 + y_2 = y_2 + x_2)$$

- This is easy to prove:

$$(x_1 = x_2 \wedge y_1 = y_2) \longrightarrow (x_1 + y_1 = x_2 + y_2)$$

- This requires **commutativity**:

$$(x_1 = x_2 \wedge y_1 = y_2) \longrightarrow (x_1 + y_1 = y_2 + x_2)$$

- Fix by adding:

$$(x_1 + y_1 = y_1 + x_1) \wedge (x_2 + y_2 = y_2 + x_2)$$

- What about *other cases*?
Use more rewriting rules!

```
int power3(int in) {
    out = in;

    for(i=0; i<2; i++)
        out = out * in;

    return out;
}

int power3_new(int in) {
    out = (in*in)*in;
    return out;
}
```

-
- These two functions return the same value regardless if it is '*' or any other function.
 - *Conclusion:* we can prove equivalence by replacing '*' with an uninterpreted function

- But first we need to know how to turn programs into equations.
- There are several options – we will see **static single assignment** for bounded programs.

- → see compiler class
- Idea: **Rename variables** such that each variable is assigned **exactly once**

Example:

<code>x=x+y;</code>		<code>x₁=x₀+y₀;</code>
<code>x=x*2;</code>		<code>x₂=x₁*2;</code>
<code>a[i]=100;</code>		<code>a₁[i₀]=100;</code>

- → see compiler class
- Idea: **Rename variables** such that each variable is assigned **exactly once**

Example:

$x = x + y;$		$x_1 = x_0 + y_0;$
$x = x * 2;$		$x_2 = x_1 * 2;$
$a[i] = 100;$		$a_1[i_0] = 100;$

- Read assignments as **equalities**
- Generate constraints by simply **conjoining** these equalities

Example:

$x_1 = x_0 + y_0;$		$x_1 = x_0 + y_0$	\wedge
$x_2 = x_1 * 2;$		$x_2 = x_1 * 2$	\wedge
$a_1[i_0] = 100;$		$a_1[i_0] = 100$	

What about if? Branches are handled using ϕ -nodes.

```
int main() {  
    int x, y, z;  
  
    y=8;  
  
    if(x)  
        y--;  
    else  
        y++;  
  
    z=y+1;  
}
```

What about if? Branches are handled using ϕ -nodes.

```
int main() {
  int x, y, z;

  y=8;

  if(x)
    y--;
  else
    y++;

  z=y+1;
}
```



```
int main() {
  int x, y, z;

  y1=8;

  if(x0)
    y2=y1-1;
  else
    y3=y1+1;

  y4= $\phi$ (y2, y3);

  z1=y4+1;
}
```

What about if? Branches are handled using ϕ -nodes.

```
int main() {
  int x, y, z;

  y=8;

  if(x)
    y--;
  else
    y++;

  z=y+1;
}
```



```
int main() {
  int x, y, z;

  y1=8;

  if(x0)
    y2=y1-1;
  else
    y3=y1+1;

  y4= $\phi$ (y2, y3);

  z1=y4+1;
}
```



```
y1 = 8           ^
y2 = y1 - 1    ^
y3 = y1 + 1    ^
y4 =
  (x0 ≠ 0 ? y2 : y3) ^
z1 = y4 + 1
```

What about loops?

→ We **unwind** them!

```
void f(...) {  
    ...  
    while(cond) {  
        BODY;  
    }  
    ...  
    Remainder;  
}
```

What about loops?

→ We **unwind** them!

```
void f(...) {  
    ...  
    if(cond) {  
        BODY;  
        while(cond) {  
            BODY;  
        }  
    }  
    ...  
    Remainder;  
}
```

What about loops?

→ We **unwind** them!

```
void f(...) {  
    ...  
    if(cond) {  
        BODY;  
        if(cond) {  
            BODY;  
            while(cond) {  
                BODY;  
            }  
        }  
    }  
    ...  
    Remainder;  
}
```

Some caveats:

- Unwind **how many times?**
- Must preserve locality of variables declared inside loop

Some caveats:

- Unwind **how many times?**
- Must preserve locality of variables declared inside loop

There is a tool available that does this

- CBMC – **C Bounded Model Checker**
- Bound is verified using **unwinding assertions**
- Used frequently for embedded software
→ Bound is a **run-time guarantee**
- Integrated into Eclipse
- Decision problem can be exported

SSA for bounded programs: CBMC

The screenshot displays the Eclipse IDE with the CBMC plugin. The main editor shows the source code for `md2_bounds.c`:

```
for (i = 0; i < 16; i++)
  x[i+32] = state[i] ^ block[i];

/* Encrypt block (18 rounds).
 */
t = 0;
for (i = 0; i < 18; i++) {
  for (j = 0; j < 48; j++)
    t = x[j] ^ PI_SUBST[t];
  t = (t + 1) & 0xFF;
}
```

The 'Claims - SATABS - md2_bounds.tsk' window shows the following table of properties:

File	Property	Description	Expression
R md2_bounds.c	bounds	array 'x' upper bound	32 + i < 48
✓ md2_bounds.c	array bound	dereference failure: array 'state' lower bound	! (i < 0) ! (c::md2_bounds::MD2Tf
✓ md2_bounds.c	array bound	dereference failure: array 'state' upper bound	! (c::md2_bounds::MD2Transform::
R md2_bounds.c	array bound	dereference failure: array 'block' lower bound	! (i < 0) ! (c::md2_bounds::MD2Tf
R md2_bounds.c	array bound	dereference failure: array 'block' upper bound	! (c::md2_bounds::MD2Transform::
W md2_bounds.c	bounds	array 'x' upper bound	TRUE
W md2_bounds.c	bounds	array 'PI_SUBST' upper bound	t < 256
W md2_bounds.c	bounds	array 'x' upper bound	TRUE
W md2_bounds.c	array bound	dereference failure: array 'block' lower bound	! (i < 0) ! (c::md2_bounds::MD2Tf
W md2_bounds.c	array bound	dereference failure: array 'block' upper bound	! (c::md2_bounds::MD2Transform::
W md2_bounds.c	bounds	array 'PI_SUBST' upper bound	(t ^ (unsigned int)(16 + block)) <

The Trace Problems window shows the following execution trace:

```
Running Cadence SMV: smv -force -sift
Cadence SMV produced counterexample
Simulating abstract transitions of counterexample on concrete program
Spurious transition found
Trace is spurious
Refining transition
*** CEGAR Loop Iteration 6
Running Cadence SMV: smv -force -sift
```

Example: equivalence of C programs (2/4)

```
int power3(int in) {  
    out = in;  
  
    for(i=0; i<2; i++)  
        out = out * in;  
  
    return out;  
}
```

```
int power3_new(int in) {  
    out = (in*in)*in;  
    return out;  
}
```

Example: equivalence of C programs (2/4)

```
int power3(int in) {  
    out = in;  
  
    for(i=0; i<2; i++)  
        out = out * in;  
  
    return out;  
}
```

```
int power3_new(int in) {  
    out = (in*in)*in;  
    return out;  
}
```

Static single assignment (SSA) form:

$$out_1 = in \wedge$$

$$out_2 = out_1 * in \wedge$$

$$out_3 = out_2 * in$$

$$out'_1 = (in * in) * in$$

Prove that both functions return the same value:

$$out_3 = out'_1$$

Static single assignment (SSA) form:

$$out_1 = in \wedge$$

$$out_2 = out_1 * in \wedge$$

$$out_3 = out_2 * in$$

$$out'_1 = (in * in) * in$$

With uninterpreted functions:

$$out_1 = in \wedge$$

$$out_2 = F(out_1, in) \wedge$$

$$out_3 = F(out_2, in)$$

$$out'_1 = F(F(in, in), in)$$

Static single assignment (SSA) form:

$$out_1 = in \wedge$$

$$out_2 = out_1 * in \wedge$$

$$out_3 = out_2 * in$$

$$out'_1 = (in * in) * in$$

With uninterpreted functions:

$$out_1 = in \wedge$$

$$out_2 = F(out_1, in) \wedge$$

$$out_3 = F(out_2, in)$$

$$out'_1 = F(F(in, in), in)$$

With numbered uninterpreted functions:

$$out_1 = in \wedge$$

$$out_2 = F_1(out_1, in) \wedge$$

$$out_3 = F_2(out_2, in)$$

$$out'_1 = F_4(F_3(in, in), in)$$

With numbered uninterpreted functions:

$$out_1 = in \wedge$$

$$out_2 = F_1(out_1, in) \wedge$$

$$out_3 = F_2(out_2, in)$$

$$out'_1 = F_4(F_3(in, in), in)$$

With numbered uninterpreted functions:

$$out_1 = in \wedge$$

$$out_2 = F_1(out_1, in) \wedge$$

$$out_3 = F_2(out_2, in)$$

$$out'_1 = F_4(F_3(in, in), in)$$

Ackermann's reduction:

$$out_1 = in \wedge$$

$$\varphi_a^E : out_2 = f_1 \wedge$$

$$out_3 = f_2$$

$$\varphi_b^E : out'_1 = f_4$$

With numbered uninterpreted functions:

$$out_1 = in \wedge$$

$$out_2 = F_1(out_1, in) \wedge$$

$$out_3 = F_2(out_2, in)$$

$$out'_1 = F_4(F_3(in, in), in)$$

Ackermann's reduction:

$$out_1 = in \wedge$$

$$\varphi_a^E : out_2 = f_1 \wedge$$

$$out_3 = f_2$$

$$\varphi_b^E : out'_1 = f_4$$

The verification condition:

$$\left[\left(\begin{array}{l} (out_1 = out_2 \rightarrow f_1 = f_2) \wedge \\ (out_1 = in \rightarrow f_1 = f_3) \wedge \\ (out_1 = f_3 \rightarrow f_1 = f_4) \wedge \\ (out_2 = in \rightarrow f_2 = f_3) \wedge \\ (out_2 = f_3 \rightarrow f_2 = f_3) \wedge \\ (in = f_3 \rightarrow f_3 = f_4) \end{array} \right) \wedge \varphi_a^E \wedge \varphi_b^E \right] \longrightarrow out_3 = out'_1$$

- Let n be the number of instances of $F()$
- Both reduction schemes require $O(n^2)$ comparisons
- This can be the *bottleneck* of the verification effort



- Let n be the number of instances of $F()$
- Both reduction schemes require $O(n^2)$ comparisons
- This can be the *bottleneck* of the verification effort



- Solution: try to *guess* the pairing of functions
- Still sound: wrong guess can only make a valid formula invalid

- Given $x_1 = x'_1$, $x_2 = x'_2$, $x_3 = x'_3$, prove $\models o_1 = o_2$.

$$o_1 = \underbrace{(x_1 + (a \cdot x_2))}_{f_1} \wedge a = \underbrace{x_3 + 5}_{f_2} \quad \text{Left}$$

$$o_2 = \underbrace{(x'_1 + (b \cdot x'_2))}_{f_3} \wedge b = \underbrace{x'_3 + 5}_{f_4} \quad \text{Right}$$

- 4 function instances \rightarrow 6 comparisons

- Given $x_1 = x'_1$, $x_2 = x'_2$, $x_3 = x'_3$, prove $\models o_1 = o_2$.

$$o_1 = \underbrace{(x_1 + (a \cdot x_2))}_{f_1} \wedge a = \underbrace{x_3 + 5}_{f_2} \quad \text{Left}$$

$$o_2 = \underbrace{(x'_1 + (b \cdot x'_2))}_{f_3} \wedge b = \underbrace{x'_3 + 5}_{f_4} \quad \text{Right}$$

- 4 function instances \rightarrow 6 comparisons
- Guess: validity does not rely on $f_1 = f_2$ or on $f_3 = f_4$
- Idea: only enforce functional consistency of pairs (Left,Right).

$$o_1 = \underbrace{(x_1 + (a \cdot x_2))}_{f_1} \wedge a = \underbrace{x_3 + 5}_{f_2}$$

Left



$$o_2 = \underbrace{(x'_1 + (b \cdot x'_2))}_{f_3} \wedge b = \underbrace{x'_3 + 5}_{f_4}$$

Right

- Down to 4 comparisons!

$$o_1 = \underbrace{(x_1 + (a \cdot x_2))}_{f_1} \wedge a = \underbrace{x_3 + 5}_{f_2}$$

Left



$$o_2 = \underbrace{(x'_1 + (b \cdot x'_2))}_{f_3} \wedge b = \underbrace{x'_3 + 5}_{f_4}$$

Right

- Down to 4 comparisons!
- Another guess: equivalence only depends on $f_1 = f_3$ and $f_2 = f_4$
- *Pattern matching* may help here

$$o_1 = \underbrace{(x_1 + (a \cdot x_2))}_{f_1} \wedge a = \underbrace{x_3 + 5}_{f_2}$$

Left

$$o_2 = \underbrace{(x'_1 + (b \cdot x'_2))}_{f_3} \wedge b = \underbrace{x'_3 + 5}_{f_4}$$

Right

Match according
to patterns
(‘signatures’)

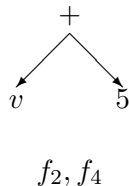
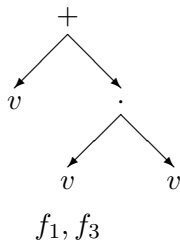

Down to 2 comparisons!

$$o_1 = \underbrace{(x_1 + (a \cdot x_2))}_{f_1} \wedge a = \underbrace{x_3 + 5}_{f_2}$$

Left

$$o_2 = \underbrace{(x'_1 + (b \cdot x'_2))}_{f_3} \wedge b = \underbrace{x'_3 + 5}_{f_4}$$

Right

Substitute
intermediate
variables (in the
example: a, b)

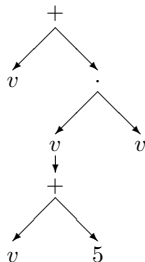

$$o_1 = \underbrace{(x_1 + (a \cdot x_2))}_{f_1} \wedge a = \underbrace{x_3 + 5}_{f_2} \quad \text{Left}$$

$$o_2 = \underbrace{(x'_1 + (b \cdot x'_2))}_{f_3} \wedge b = \underbrace{x'_3 + 5}_{f_4} \quad \text{Right}$$

Substitute
intermediate
variables (in the
example: a, b)

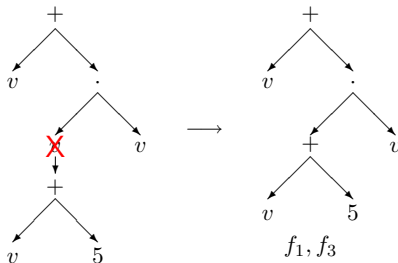

With numbered uninterpreted functions:

$$out_1 = in \wedge$$

$$out_2 = F_1(out_1, in) \wedge$$

$$out_3 = F_2(out_2, in)$$

$$out'_1 = F_4(F_3(in, in), in)$$

With numbered uninterpreted functions:

$$out_1 = in \wedge$$

$$out_2 = F_1(out_1, in) \wedge$$

$$out_3 = F_2(out_2, in)$$

$$out'_1 = F_4(F_3(in, in), in)$$

Map F_1 to F_3 :

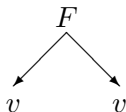

Map F_2 to F_4 :

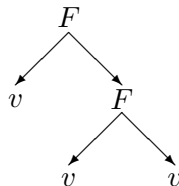

With numbered uninterpreted functions:

$$out_1 = in \wedge$$

$$out_2 = F_1(out_1, in) \wedge$$

$$out_3 = F_2(out_2, in)$$

$$out'_1 = F_4(F_3(in, in), in)$$

Ackermann's reduction:

$$out_1 = in \wedge$$

$$\varphi_a^E : out_2 = f_1 \wedge$$

$$out_3 = f_2$$

$$\varphi_b^E : out'_1 = f_4$$

The verification condition has *shrunk*:

$$\left[\left(\begin{array}{l} (out_1 = in \longrightarrow f_1 = f_3) \\ (out_2 = f_3 \longrightarrow f_2 = f_4) \end{array} \wedge \right) \wedge \varphi_a^E \wedge \varphi_b^E \right] \longrightarrow out_3 = out'_1$$

With numbered uninterpreted functions:

$$out_1 = in \wedge$$

$$out_2 = F_1(out_1, in) \wedge \quad out'_1 = F_4(F_3(in, in), in)$$

$$out_3 = F_2(out_2, in)$$

Bryant's reduction:

$$\varphi_a^E : out_1 = in \wedge$$

$$out_2 = f_1 \wedge$$

$$out_3 = f_2$$

$$\varphi_b^E : out'_1 =$$

$$\left(\text{case } \left(\text{case } \begin{array}{l} in = out_1: f_1 \\ \text{true} : f_3 \end{array} \right) = out_2: f_2 \right) : f_4$$

The verification condition:

$$(\varphi_a^E \wedge \varphi_b^E) \longrightarrow out_3 = out'_1$$

So is Equality Logic with UFs interesting?

- 1 It is **expressible enough** to state something interesting.
- 2 It is decidable and **more efficiently solvable** than richer logics, for example in which some functions are interpreted.
- 3 Models which rely on infinite-type variables are expressed **more naturally** in this logic in comparison with Propositional Logic.

